













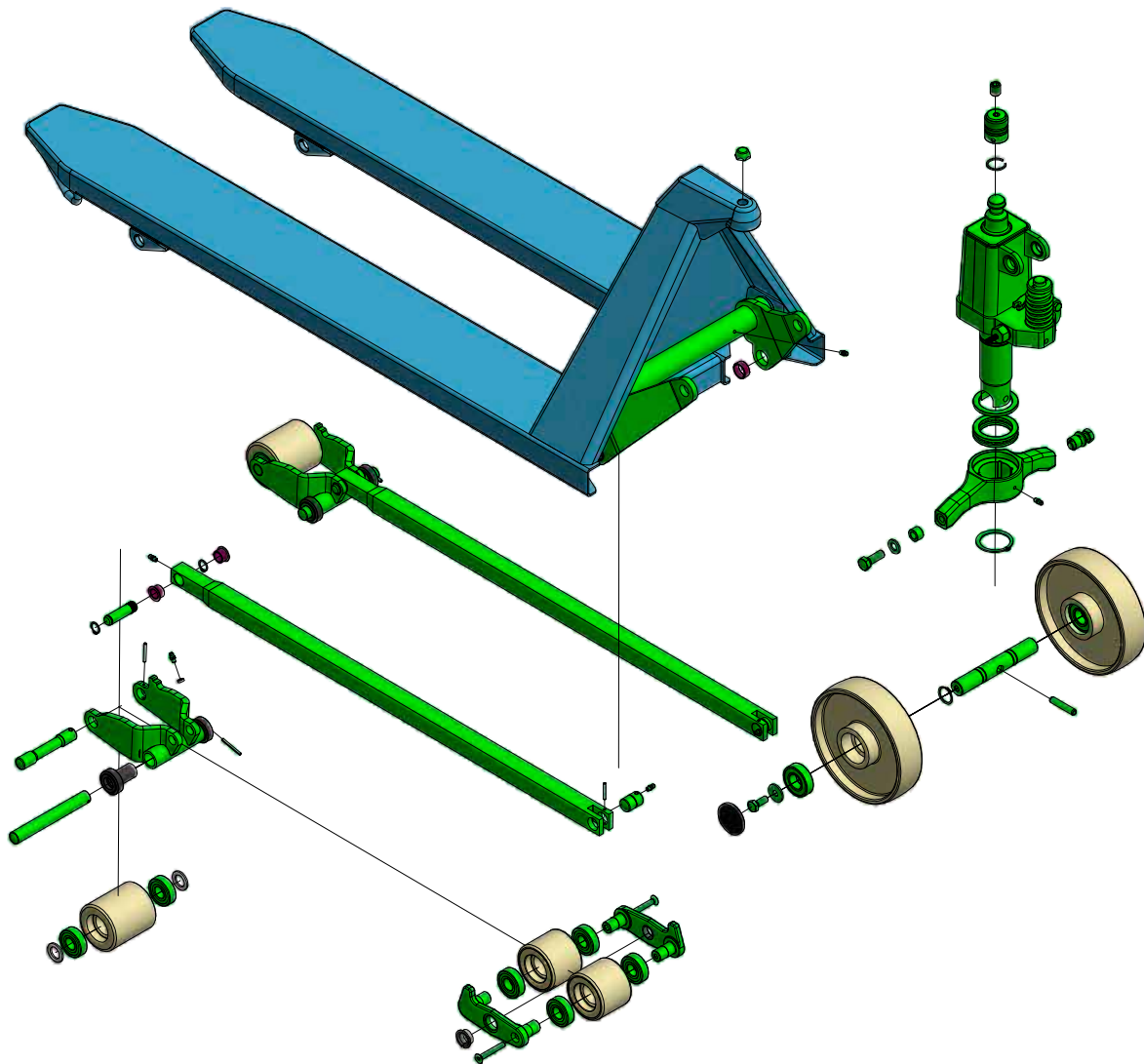

PANTHER INOX PLUS

	Syrefast stål	Acid-resistant steel	Säurebeständiger Stahl	Inox - Anti acides	EN 1.4404 (AISI 316L) EN 1.4460 (AISI 329)
	Rustfrit stål	Stainless steel	Edelstahl	Inox	EN 1.4305 (AISI 303) EN 1.4301 (AISI 304)
	Zink/Jern sort passivering med sealer	Zinc-iron black passivating + sealer	Zink/Eisen schwarz passiviert + Versiegelung	Zinc/traitement de surface polymère noir	Fe//ZnFeX//Fn//T2
	Zink/Jern silver passivering med sealer	Zinc-iron silver passivating + sealer	Zink/Eisen silber passiviert + Versiegelung	Zinc/traitement de surface polymère argenté	Fe//ZnFeX//Cn//T2
	Gummitættnede lejer	Rubber sealed bearings	Lager m/Gummidichtung	Roulements étanches	
	Bronze	Bronze	Bronze	Bronze	
	Malet 130-150 µm	Painted 130-150 µm	Gemalt 130-150 µm	Peinture 130-150 µm	



PANTHER INOX PLUS

	Syrefast stål	Acid-resistant steel	Säurebeständiger Stahl	Inox - Anti acides	EN 1.4404 (AISI 316L) EN 1.4460 (AISI 329)
	Rustfrit stål	Stainless steel	Edelstahl	Inox	EN 1.4305 (AISI 303) EN 1.4301 (AISI 304)
	Zink/Jern sort passivering med sealer	Zinc-iron black passivating + sealer	Zink/Eisen schwarz passiviert + Versiegelung	Zinc/traitement de surface polymère noir	Fe//ZnFeX//Fn//T2
	Zink/Jern silver passivering med sealer	Zinc-iron silver passivating + sealer	Zink/Eisen silber passiviert + Versiegelung	Zinc/traitement de surface polymère argenté	Fe//ZnFeX//Cn//T2
	Gummitættnede lejer	Rubber sealed bearings	Lager m/Gummidichtung	Roulements étanches	
	Bronze	Bronze	Bronze	Bronze	
	Malet 130-150 µm	Painted 130-150 µm	Gemalt 130-150 µm	Peinture 130-150 µm	

